

Maximum Ratings

Parameters Description	Unit	Minimum	Typical	Maximum
Operation Temperature Range	°C	-	25	-
Storage Temperature Range	°C	-40	-	85
Maximum DC Voltage	V	-	-	10
Maximum Input Power	dBm	-	-	10
Source Impedance (single ended) ⁽¹⁾	Ω	-	50	-
Load Impedance (single ended) ⁽¹⁾	Ω	-	50	-
Package type & size	D			
Length x Width	mm ²	-	20.0x12.6	-
Height	mm	-	-	5.05

Electrical Specification

Center Frequency (Fo)	MHz	-	62.5	-
Insertion Loss at Fo	dB	-	22.5	24.0
Group Delay Variation (Fo±9.22MHz)	ns	-	35	80
Absolute Delay Time at Fo	us	-	2.33	-
Temperature Coefficient	ppm/°C	-	-72	-
Amplitude Ripple (Fo±9.22MHz)	dB	-	0.65	1.00
Bandwidth at -1dB	MHz	-	19.10	-
Bandwidth at -3dB	MHz	19.20	19.50	-
Bandwidth at -50dB	MHz	-	20.93	21.00
Ultimate Rejection	dB	50	53	-

Notes : (1) With Matching Network (Ref. Testing Environment Circuit as shown below).

Those impedances could be modified with different impedance values and/or structures, if necessary.

Package Dimensions

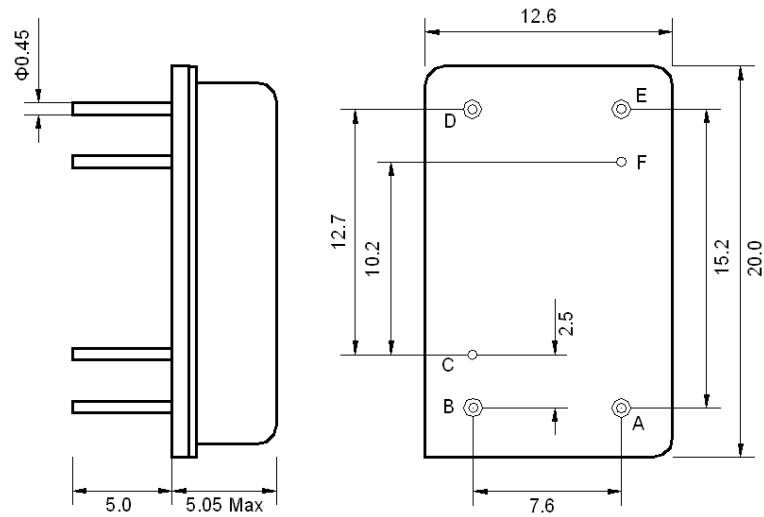

Pin Description	
B, C, D, F	Ground
A	Input
E	Output

Testing Environment

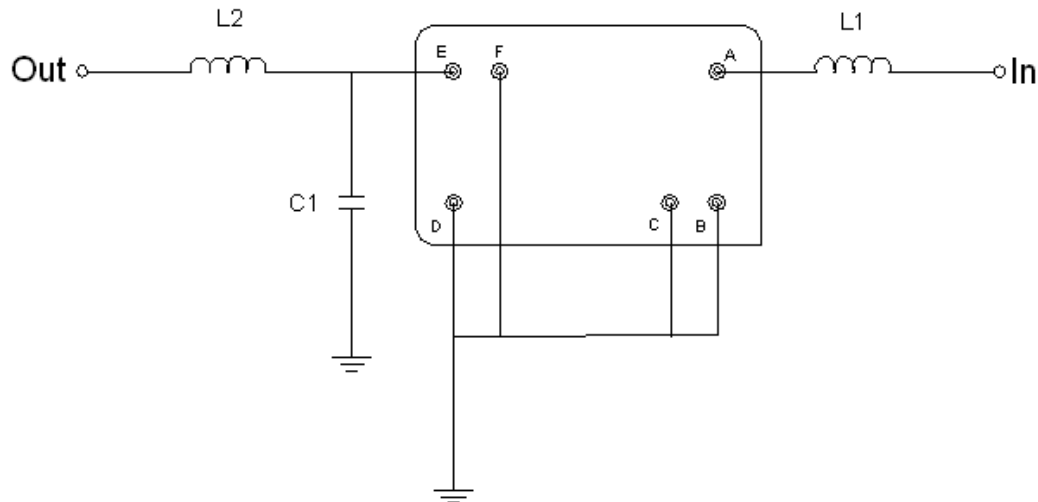

Test Fixture & Values	
Input	L1=220 nH
Output	L2=220 nH, C1=3.6pF
Source/Load Impedance	50 Ω

Frequency Response

Bandwidth at -1.0 dB

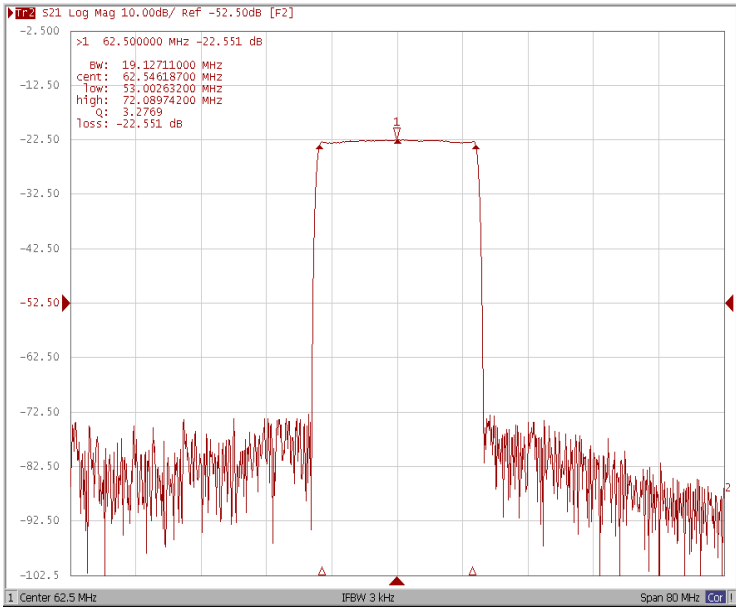

Bandwidth at -3.0 dB

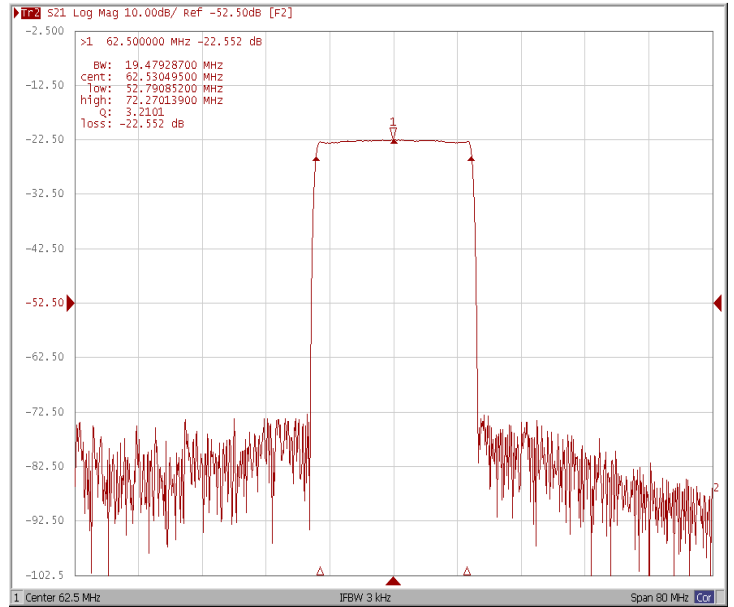

Bandwidth at -50.0 dB

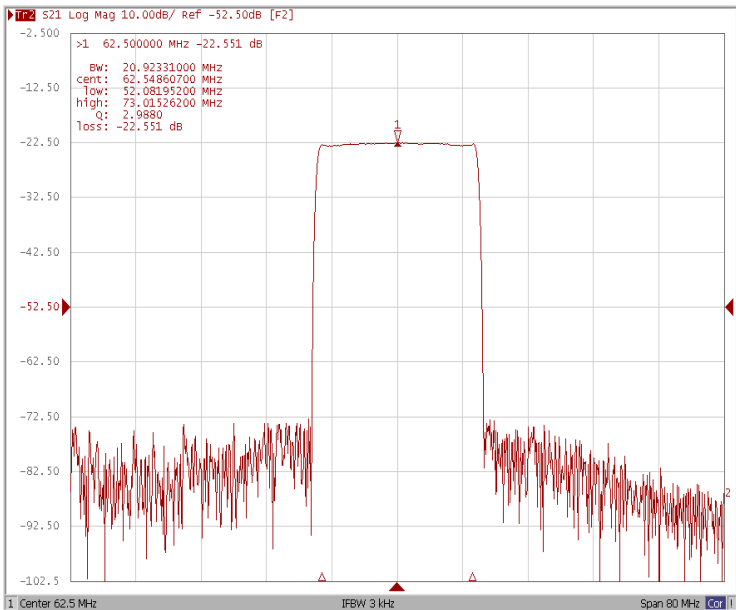

Wide_Band

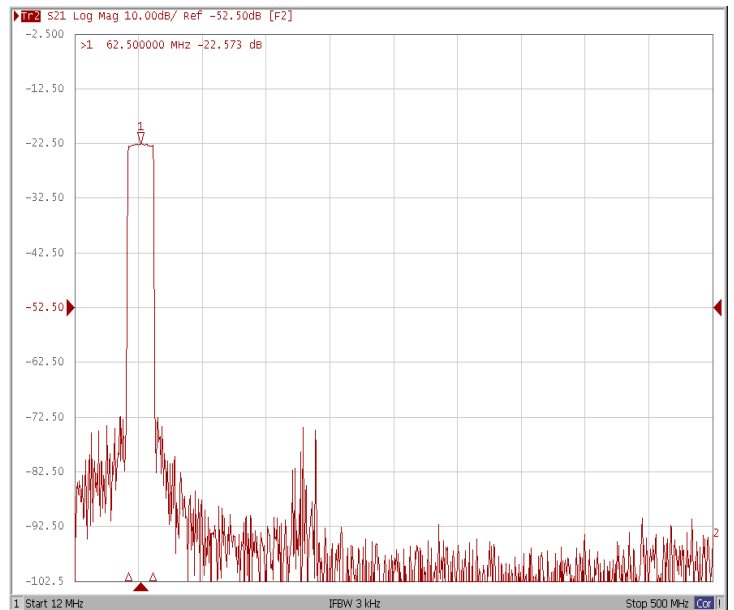

Frequency Response

Ripple Variation Fo±9.22MHz

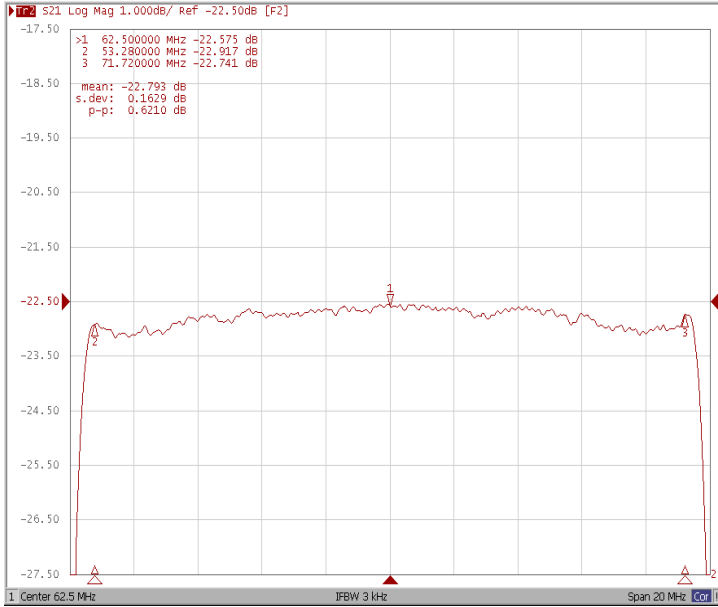

Group Delay Variation Fo±9.22MHz

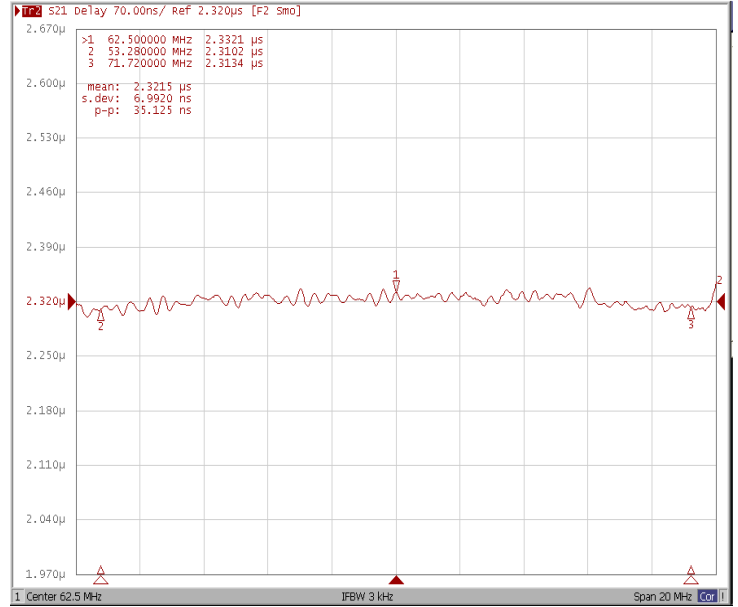

Smith Chart

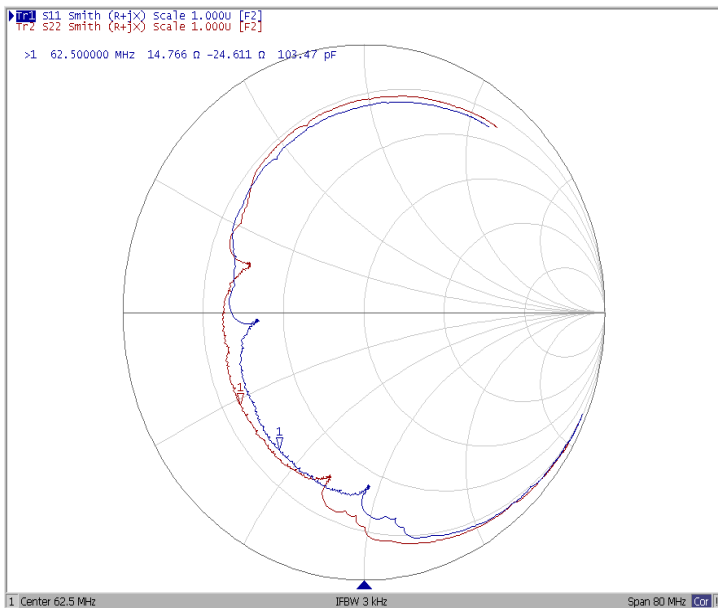

VSWR

