

## Maximum Ratings

Parameters Description	Unit	Minimum	Typical	Maximum
Operation Temperature Range	°C	20		50
Storage Temperature Range	°C	-45	-	85
Maximum DC Voltage	V	-	-	10
Maximum Input Power	dBm	-	-	10
Source Impedance (single ended) <sup>(1)</sup>	Ω	-	50	-
Load Impedance (single ended) <sup>(1)</sup>	Ω	-	50	-
Package type & size	V			
Length x Width	mm <sup>2</sup>	-	13.3 x 6.5	-
Height	mm	-	-	1.8

## Electrical Specification

Parameters Description	Unit	Minimum	Typical	Maximum
Center Frequency (Fo)	MHz	-	184.00	-
Insertion Loss at Fo	dB	-	28.5	30.0
Group Delay Variation (Fo±7.5MHz)	ns	-	40	80
Absolute Delay	us	-	2.00	-
Passband Ripple (Fo±7.5MHz)	dB	-	0.65	1.0
Bandwidth at -1dB	MHz	15.20	15.45	-
Bandwidth at -3dB	MHz	-	15.90	-
Bandwidth at -40dB	MHz	-	17.60	17.90
Ultimate Rejection	dB	45	50	-
Relative Attenuation Fo±9.0MHz	dB	45	55	-
Temperature Coefficient	ppm/°C	-	-18	-

**Notes :** (1) With Matching Network (Ref. Testing Environment Circuit as shown below).  
Those impedances could be modified with different impedance values and/or structures, if necessary.

## Package Dimensions

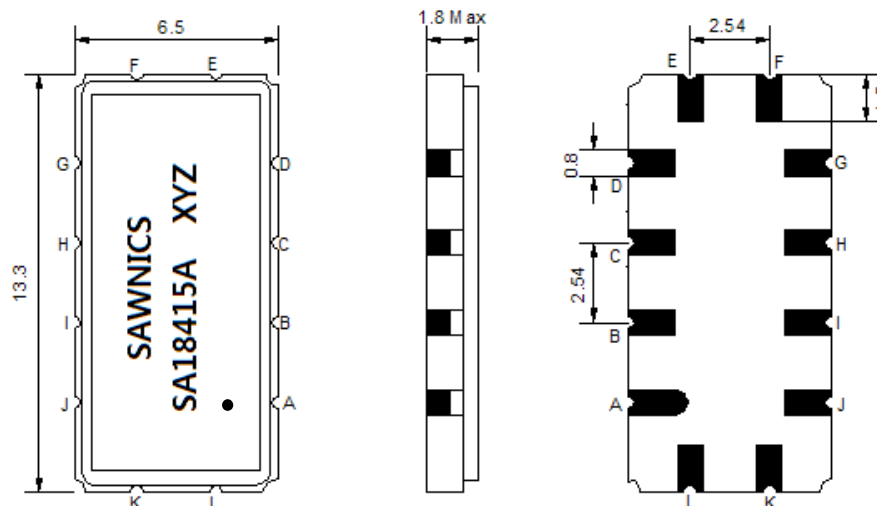

- ① SAWNICS: Brand
- ② SA18415A: Model Name
- ③ X : Date Code (Year)
- ④ Y : Date Code (Month)
- ⑤ Z : Date Code (Date)
- : Index Dot

Pin Description	
A, B, C, D, F, G, H, I, J, L	Ground
K	Input
E	Output

## Testing Environment

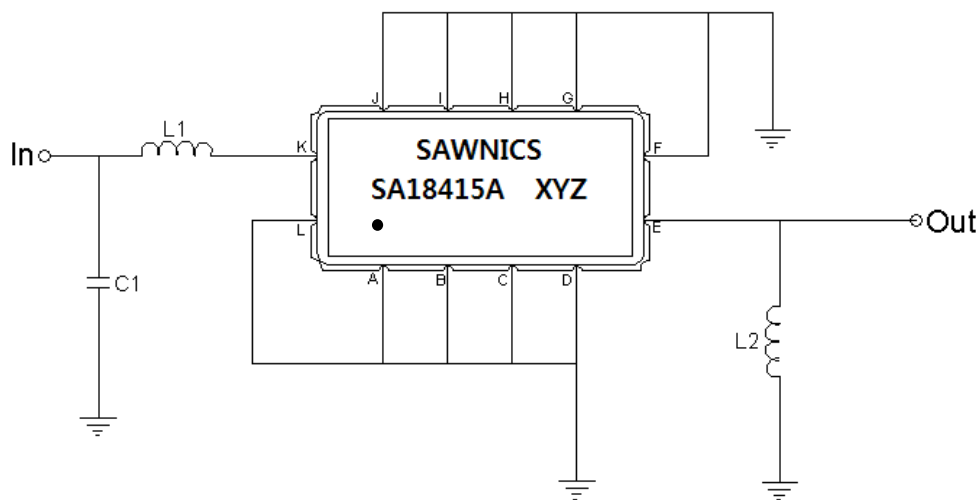

Test Fixture & Values	
Input	L1=39 nH, C1=24 pF
Output	L2=27 nH,
Source/Load Impedance	50 $\Omega$

## Frequency Response

Bandwidth at -1.0 dB

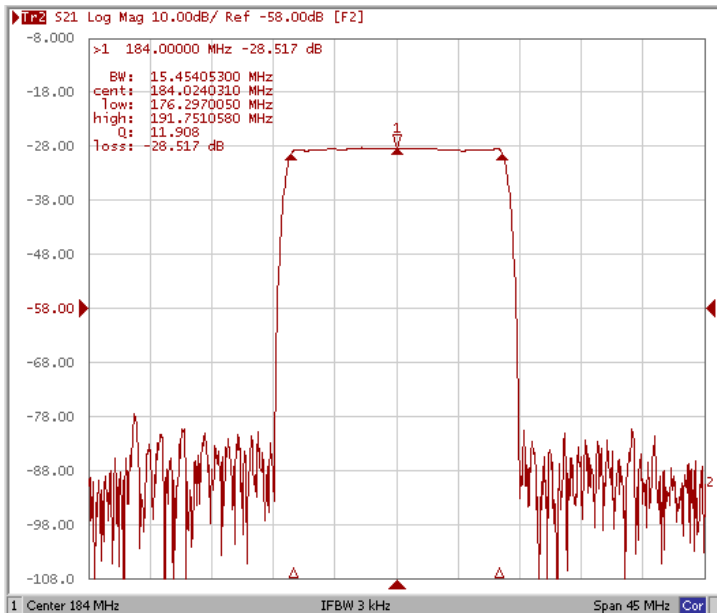

Bandwidth at -3.0 dB

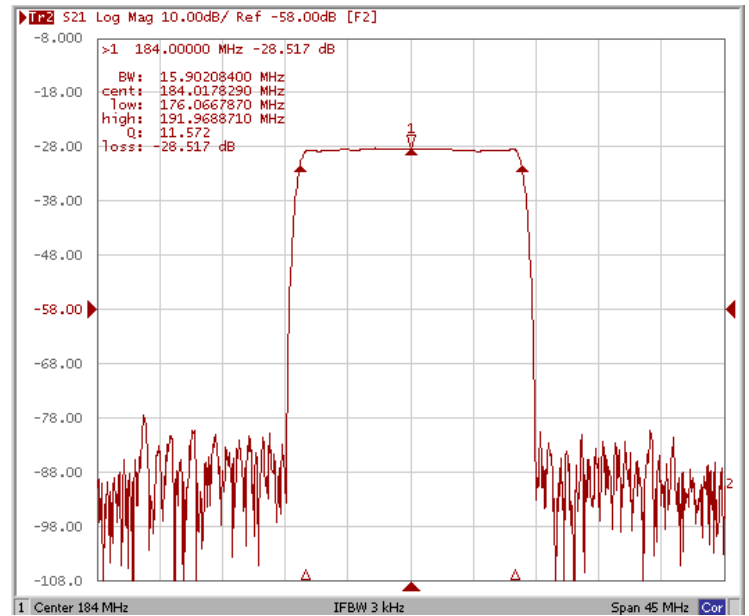

Bandwidth at -40.0 dB

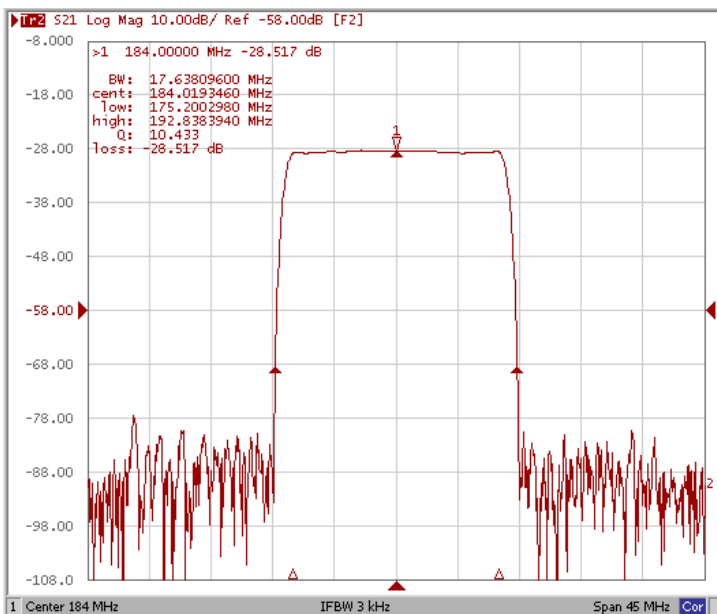

Relative Attenuation Fo±9.0MHz

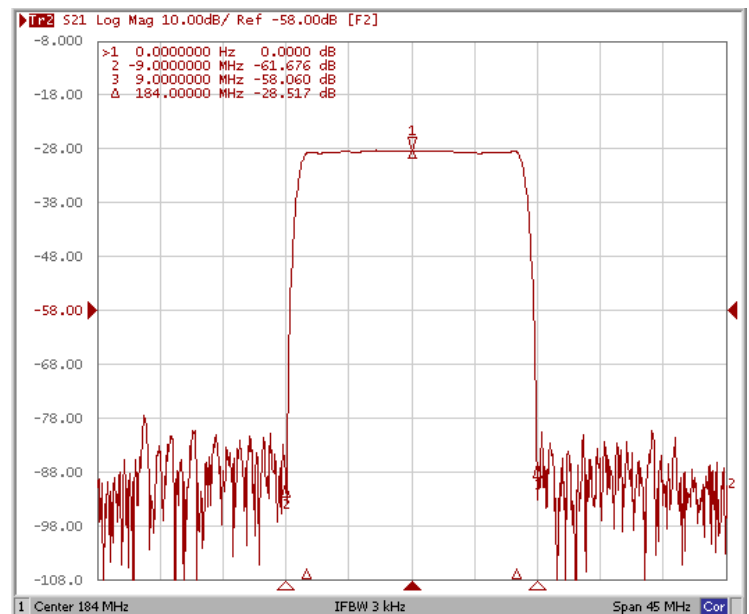

# Frequency Characteristics

## Frequency Response

Ripple Variation Fo±7.5MHz

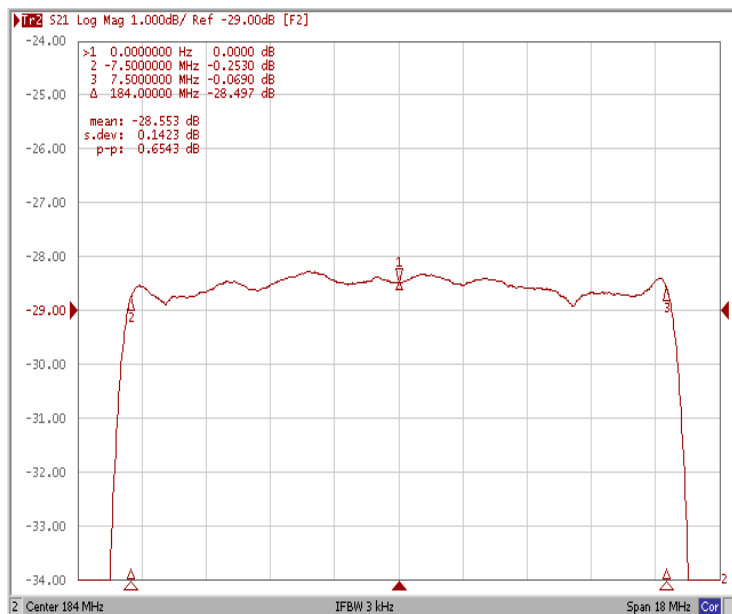

Group Delay Variation Fo±7.5MHz

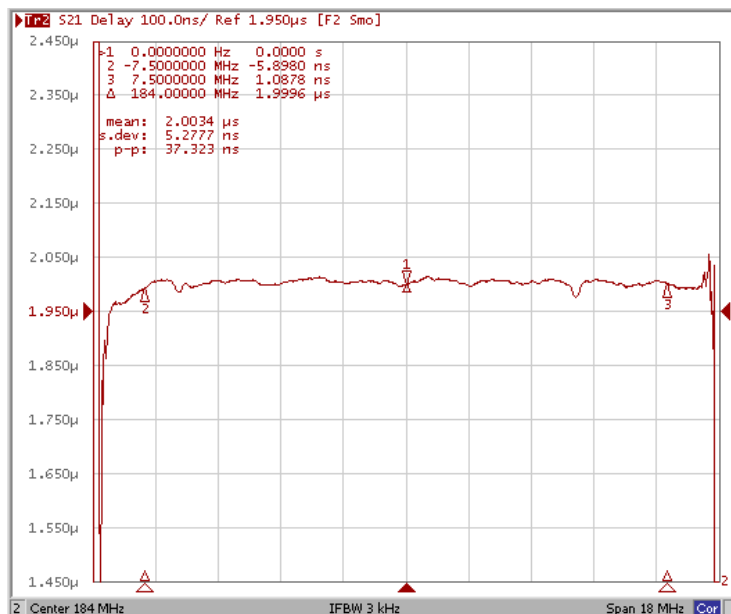

Smith Chart

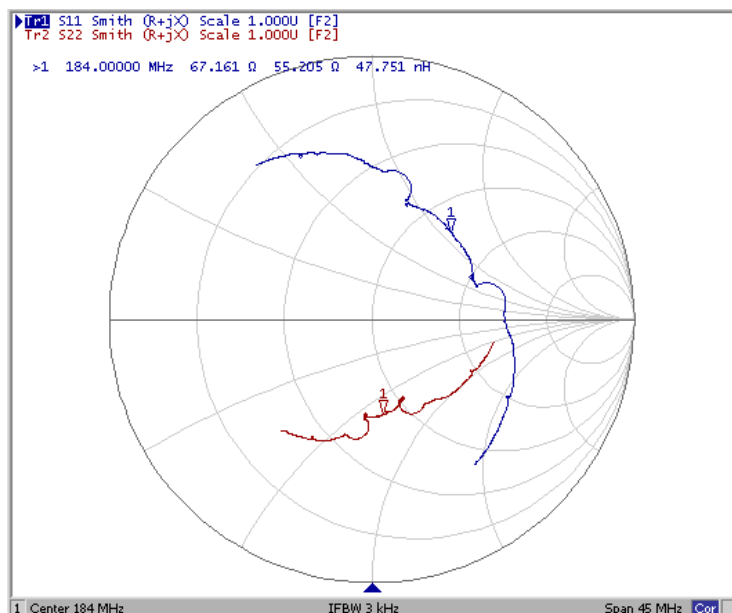

VSWR

